

JESSE RAST ENTERPRISES

If you need your equipment **FAST** stick with the **RAST!**

Independent Distributor **CATALOGUE**



CONSTRUCTION
ATTACHMENTS, INC.
PROUDLY MADE IN THE USA

JesseRastEnterprises.com **803-420-4102**

About Us

Rast Family Farms have been in operation since 1889, harvesting generations of appreciation for hard work, honesty, and dependability. Southern living at it's finest, and hardest of times. Through it all – we pull together, for the love of God, Family, Land, and Selflessness.

Jesse Rast Enterprises has taken the family values from decades of farming, planting the seed for a better way to procure farm and agricultural equipment by eliminating “the man”, speeding up delivery, and doing what’s right. Family is special and we choose to specialize in farm and agricultural equipment.

Unlike traditional distribution, Jesse Rast Enterprises runs the equipment that is available in our portfolio.

Farm life is not transactional, and you will feel the difference in honest guidance and feedback by becoming a part of the Jesse Rast Enterprises family.





CONSTRUCTION
/// ATTACHMENTS, INC.
PROUDLY MADE IN THE USA

JESSE RAST ENTERPRISES



CONSTRUCTION ATTACHMENTS, INC. PROUDLY MADE IN THE USA

PRODUCT GUIDE ATTACHMENT AND APPLICATION SELECTION

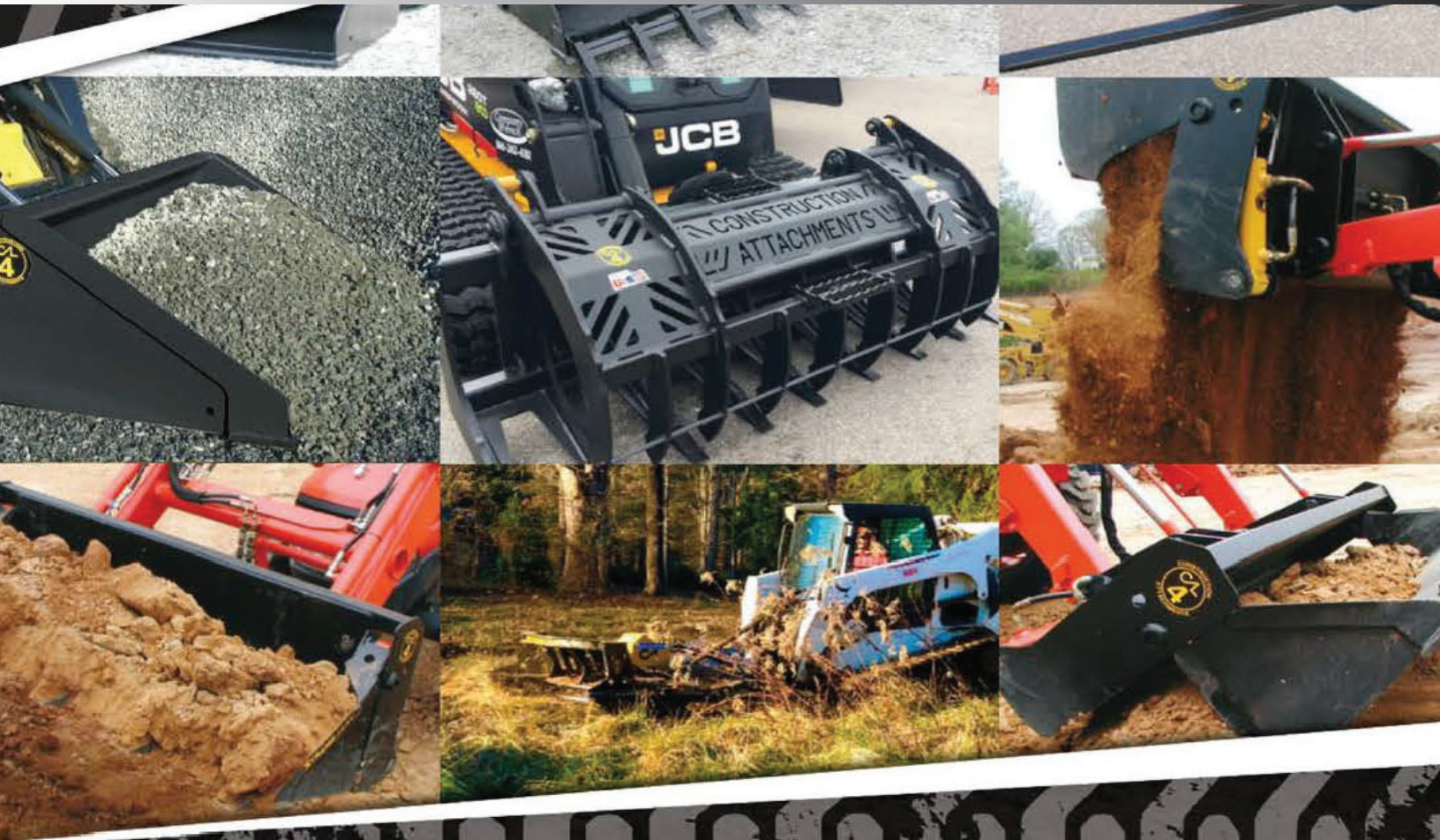

HYDRAULIC BREAKERS



DESIGNED FOR AIDING IN CONSTRUCTION AND DEMOLITION OF CONCRETE STRUCTURES, ROCKS, ASPHALT, ETC.

FOR COMPACT EXCAVATORS, TRACTOR LOADER BACKHOES AND MID/LARGE EXCAVATORS

PRODUCT FEATURES:

- More power, more impact energy per dollar than any hammer on the market
- Designed with fewer parts to insure quicker and less costly maintenance
- Excavator models come complete with mounting bracket, hoses and 1 point of choice.

(additional charge for tamping pad and asphalt cutter)

WARNING: Chisel paste must be used with hydraulic breakers. Using high temperature grease as a substitution for chisel paste will cause damage to components of breaker.



Item #	Description	Operating Pressure PSI	Oil Flow Required GPM	Machine Weight Class lbs	Tool Dia.	Hose Diameter & Length	Est Weight lbs
1BR225C-EX	CAL 225C Hydraulic Breaker	1,305-1,740	3.76-6.6	1,400-3,000	1.77"	1/2"x80"	294
1BR500C-EX	CAL 500C Hydraulic Breaker	1,280-1,710	7.0-16.0	3,000-8,000	2.24"	1/2"x80"	406
1BR650C-EX	CAL 650C Hydraulic Breaker	1,565-2,347	9.25-18.49	5,000-9,000	2.76"	3/4"x80"	546
1BR850C-EX	CAL 850C Hydraulic Breaker	1,740-2,393	10.57-22.1	5,000-11,000	2.95"	3/4"x80"	836
1BR1000C-EX	CAL 1000C Hydraulic Breaker	2,030-2,465	14.6-24.8	7,000-15,000	3.15"	3/4"x80"	1020
1BR1200C-EX	CAL 1200C Hydraulic Breaker	2,030-2,465	15.9-26.4	10,000-20,000	3.54"	3/4"x80"	1220
1BR2200C-EX	CAL 2200C Hydraulic Breaker	2,030-2,610	23.8-37.1	20,000-32,000	4.14"	3/4"x80"	2186

Models 225C-2200C are available with a quick coupler or pin-on hitch. Specify make and model of host machine when ordering. Weights may vary based on selected hitch styles.

HYDRAULIC BREAKERS



DESIGNED FOR AIDING IN CONSTRUCTION AND DEMOLITION OF CONCRETE STRUCTURES, ROCKS, ASPHALT, ETC.

FOR COMPACT EXCAVATORS, TRACTOR LOADER BACKHOES AND MID/LARGE EXCAVATORS (CONT'D)

WARNING: Chisel paste must be used with hydraulic breakers. Using high temperature grease as a substitution for chisel paste will cause damage to components of breaker.

Item #	Description	Operating Pressure PSI	Oil Flow Required GPM	Machine Weight Class lbs	Tool Dia.	Hose Diameter & Length	Est Weight lbs
1BR2200C-EX	CAL 2200C Hydraulic Breaker	3,030-2,610	23.8-37.1	20,000-32,000	4.14"	3/4"x80"	2186
1BR3200C-EX	CAL 3200C Hydraulic Breaker	2,320-2,750	34.4-68.7	32,000-44,000	4.92"	1"x90"	3490
1BR4500C-EX	CAL 4500C Hydraulic Breaker	2,320-2,750	34.4-68.7	36,000-56,000	5.32"	1"x90"	4294
1BR6000C-EX	CAL 6000C Hydraulic Breaker	2,320-2,750	14.6-73.9	44,000-70,000	5.90"	1-1/4"x108"	5764
1BR8000C-EX	CAL 8000C Hydraulic Breaker	2,320-2,750	47.6-84.5	70,000-90,000	6.10"	1-1/4"x108"	6430
1BR11000C-EX	CAL 11000C Hydraulic Breaker	2,320-2,750	68.7-105.7	88,000-140,000	6.89"	1-5/8"x110"	7810
1BR18000C-EX	CAL 18000C Hydraulic Breaker	2,320-2,750	95.0-119.0	132,000-220,000	8.26"	1-5/8"X110"	15432

AUTO LUBE SYSTEMS



item# 6BPCAUTOLUBE5



item# 6BPCAUTOLUBE6



item# 6BPCAUTOLUBE12

6BPCAUTOLUBE5	Hammer mounted refillable vibratory auto lube	CAL 550 - CAL 2200
6BPCAUTOLUBE6	Hammer mounted large refillable vibratory auto lube	CAL 3200 - CAL 18000
6BPCAUTOLUBE12	Electric adjustable machine mounted 12V auto lube	CAL 1200 - CAL 18000
6BPCAUTOLUBE24	Electric adjustable machine mounted 24V auto lube	CAL-1200 - CAL-18000

Models 3200C - 18000C come standard with pin-on hitches with pins and locking collar. Specify make and model of host machine when ordering. Weights may vary based on selected hitch styles.

HYDRAULIC BREAKERS



DESIGNED FOR AIDING IN CONSTRUCTION AND DEMOLITION OF CONCRETE STRUCTURES, ROCKS, ASPHALT, ETC.

FOR SKID STEER LOADERS

PRODUCT FEATURES:

- More power, more impact energy per dollar than any hammer on the market
- Designed with fewer parts to insure quicker and less costly maintenance
- Skid steer models come complete with skid steer mounting bracket, hoses, flat faced couplers and 1 point of choice.

(additional charge for tamping pad and asphalt cutter)

WARNING: Chisel paste must be used with hydraulic breakers. Using high temperature grease as a substitution for chisel paste will cause damage to components of breaker.



SHOWN WITH BREAKER STAND (SOLD SEPARATELY)

Item #	Description	Operating Pressure PSI	Oil Flow Required GPM	Machine Weight Class lbs	Tool Dia.	Hose Diameter & Length	Est Weight lbs
1BR225C-SS	CAL 225C Hydraulic Breaker	1,305-2,000	3.76-6.6	1,400-3,000	1.77"	1/2"x80"	296
1BR500C-SS	CAL 500C Hydraulic Breaker	1,280-2,500	6.08-16.0	3,000-8,000	2.24"	1/2"x80"	724
1BR650C-SS	CAL 650C Hydraulic Breaker	1,565-3,500	9.25-18.49	5,000-9,000	2.76"	3/4"x120"	846
1BR850C-SS	CAL 850C Hydraulic Breaker	2,000-3,500	10.57-22.1	5,000-11,000	2.95"	3/4"x120"	968
1BR1000C-SS	CAL 1000C Hydraulic Breaker	2,030-3,500	14.6-24.8	7,000-15,000	3.15"	3/4"x120"	1220

Specify make and model of host machine when ordering.

DESIGNED FOR AIDING IN CONSTRUCTION AND DEMOLITION OF CONCRETE STRUCTURES, ROCKS, ASPHALT, ETC.

Hydraulic Breaker Accessories

MOUNTING BRACKETS

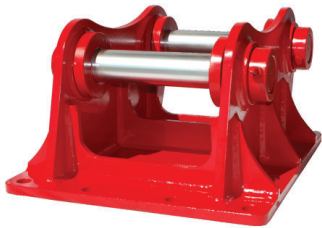

Pin-on Excavator

- Available for all Excavator models
- Pins and locking collars come standard



Skid Steer Universal

- Available for all Skid Steer models
- Comes standard on all Skid Steer model breakers



Dual Mounting Bracket

- Available for all Compact Excavator, Backhoe, and Skid Steer models
- Allows for quick change between Compact Excavator, Backhoe, and Skid Steer machines

CHISEL TOOLS FOR HYDRAULIC BREAKERS

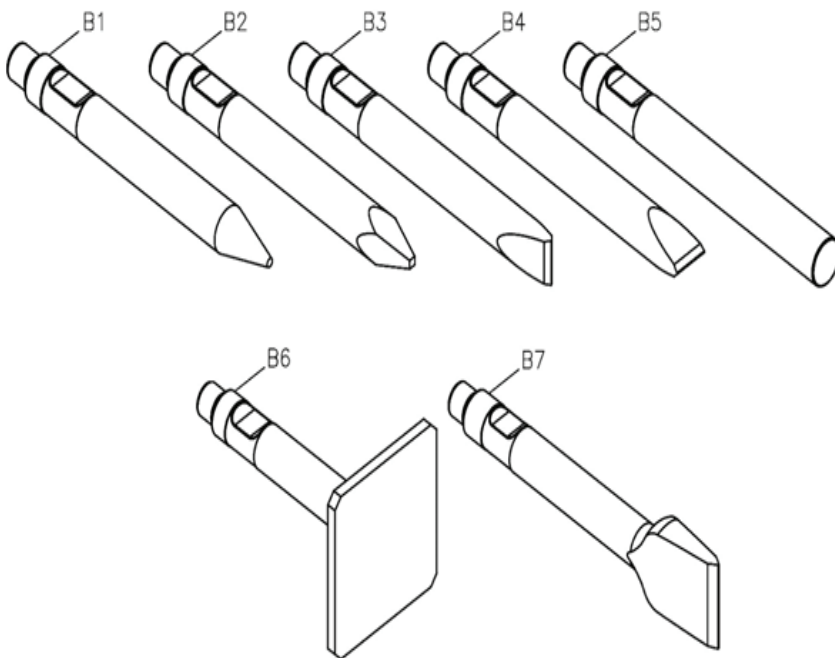

Item	Description	Available Models
B1	Conical Point	All Models
B2	Moil Point	All Models
B3	Cross-Cut Chisel	All Models
B4	In-Line Chisel	All Models
B5	Blunt Point	All Models
B6	Tamping Pad	CAL 650 - CAL 1200
B7	Asphalt Cutter	CAL 650 - CAL 1200

HYDRAULIC ROTARY BRUSH CUTTERS



LAND CLEARING MACHINES, POWERFUL, AND VERSATILE ENOUGH TO CUT THROUGH OVERGROWN BRUSH, TREES, AND DENSE TERRAIN

For Skid Steer and Compact Track Loaders

Powered by:
EATON



	60" Cutter	72" Cutter
Overall Cutter Width	70"	82"
Overall Cutter Depth	77"	84"
Overall Cutter Height	25"	

Item #	Description	# of Blades	Cutting Capacity Diameter	True Cut Width	Min Cut Height	Oil Flow Required GPM	Tip Speed FPM	Est Weight (lbs)
1BCSS60	60" Skid Steer Cutter Standard Flow	3	8"	60"	2"	16-25	7,700-13,600	1626
1BCSS60T	60" Skid Steer Cutter Standard Flow with Teeth							1636
1BCSS72	72" Skid Steer Cutter Standard Flow			72"				1964
1BCSS72T	72" Skid Steer Cutter Standard Flow with Teeth							1974
1BCSS72HF	72" Skid Steer Cutter High Flow	3	8"	72"	2"	24-45	7,700-14,600	1994
1BCSS72HFT	72" Skid Steer Cutter HighFlow with Teeth							2004

PRODUCT FEATURES:

- 5/8" thick serrated blade carrier
- 5/8" x 1-1/2" long shank mulching teeth
- 12 teeth per carrier both 60" and 72" models
- Carbide tip cutting surface: 1/2"
- Carbide tip cutting depth: 7/8"
- Wire guard installed for gear box seal protection

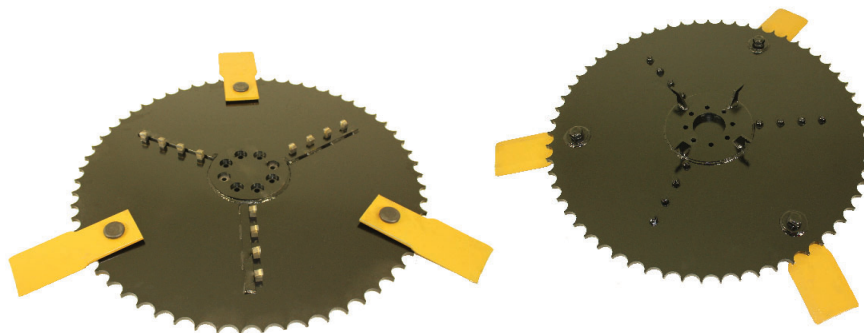

- Blade Size: 6" wide x 14.375" Long
- SS Blade Kit (Blade, Bolt, Lock Washer, and Nut (Nuts must be welded))



- Replacement Mulching Teeth

* Product design subject to change

HYDRAULIC ROTARY BRUSH CUTTERS



LAND CLEARING MACHINES, POWERFUL, AND VERSATILE ENOUGH TO CUT THROUGH OVERGROWN BRUSH, TREES, AND DENSE TERRAIN

For Mini / Compact Excavators



EXCAVATOR CUTTER PRODUCT FEATURES:

- Wire guard installed on carrier
- 1/2" thick blade carrier
- Integrated deck and hitch with new thumb design
- Recessed carrier design for bolt head protection

	42" Cutter	48" Cutter
Overall Cutter Width	48"	54"
Overall Cutter Depth	48"	54"
Overall Cutter Height	24"	

Item #	Description	# of Blades	Cutting Capacity Diameter	True Cut Width	Min Cut Height	Oil Flow Required GPM	Tip Speed FPM	Est Weight (lbs)
1BCEX4255QC	42" Mini EX Brush Cutter 55cc Motor	2	6"	42"	1"	14-21	5,500-14,500	655
1BCEX4855QC	48" Mini EX Brush Cutter 55cc Motor	3		48"				728
1BCEX4280QC	42" Mini EX Brush Cutter 80cc Motor	2	6"	42"	1"	20-27	5,500-14,500	670
1BCEX4880QC	48" Mini EX Brush Cutter 80cc Motor	3		48"				743



- Blade Size: 6" wide x 11.94" long
- EX Blade Kit (Blade, Bolt, Lock Washer, and Nut (Nuts must be welded))

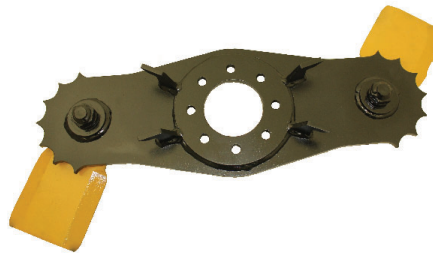

• 42" Excavator Cutter Blade Carrier



• 48" Excavator Cutter Blade Carrier

* Product design subject to change

EXCAVATOR BUCKETS-COUPPLERS-THUMBS



DIGGING • HILL SCRAPING • TRENCHING • LOADING • BACK GRADING • EXCAVATING

**Specifically designed for increased machine performance
and long term durability**



EXCAVATOR BUCKET PRODUCT FEATURES:

- 1" beveled C1060 front cutting edge
- AR plate front side cutters, side plates and wear strips
- Integrated hitch backing plate and square top tube design add additional strength
- CAT style teeth
- Smooth edge also available
- Available widths: 12", 16", 18", 24", 30", 36" and 48"
- Available loader size (LBS): 6-10k, 11-15k, 16-20k
- Quick attach or pin-on available



- Shown with select pin on mount

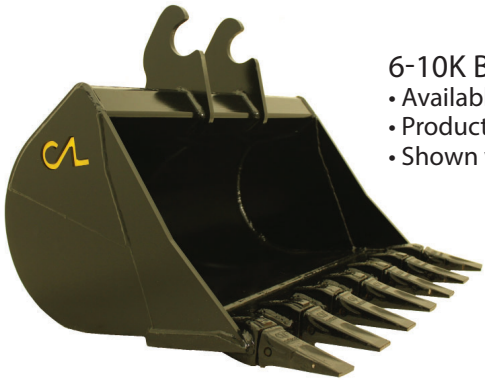

6-10K BUCKETS

- Available widths: 12"-36"
- Product weight range: 158 – 380 lbs
- Shown with Kubota KX 040QC mount



11-15K BUCKETS

- Available widths: 12"-48"
- Product weight range: 190– 587 lbs
- Shown with Kubota KX 057QC mount



16-20K BUCKETS

- Available widths: 18"-48"
- Product weight range: 472– 1323 lbs
- Shown with Kubota KX 080QC mount

* Product design subject to change

DIGGING • HILL SCRAPING • TRENCHING • LOADING • BACK GRADING • EXCAVATING

**Specifically designed for increased machine performance
and long term durability**

KUBOTA STYLE COUPLER

PRODUCT FEATURES:

- Turn your pin on excavators into a quick attach
- Available loader sizes: 6-10k, 11-15k, 16-20k



HYDRAULIC THUMB

PRODUCT FEATURES:

- Enhanced durability and operator accuracy during clamping
- Constructed of AR plate material
- Integral design increases surface area when clamping
- Larger diameter cylinder rod for increased clamping force
- Ridged / radical tooth design for aggressive applications
- Available in hydraulic only
- Available loader sizes: 6-10k, 11-15k, 16-20k

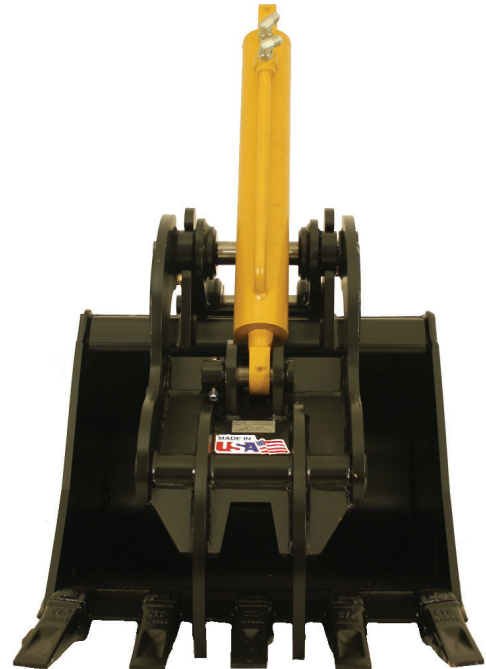

GENERAL PURPOSE BUCKETS



DIGGING • LEVELING • LOADING • GRADING • CARRYING • DUMPING

GENERAL PURPOSE BUCKET ATTACHMENT OPTIONS

Our buckets include product specific

- reversible bolt-on cutting edge
- bolt-on teeth
- bolt-on large teeth
- weld-on teeth
- bolt-on tooth bar
- bolt-on extended tooth bar



MINI SKID STEER STANDARD BOTTOM

- Available widths: 36", 44", 50"
- Product weight range: 152 – 208 lbs



MINI SKID STEER HIGH CAPACITY

- Available widths: 36", 44", 50"
- Product weight range: 161 – 220 lbs

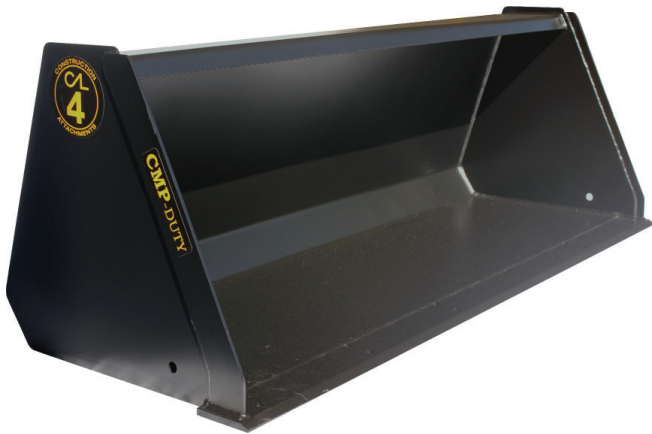

COMPACT GENERAL PURPOSE

- Available widths: 54", 60", 66", 72"
- Product weight range: 203 – 386 lbs

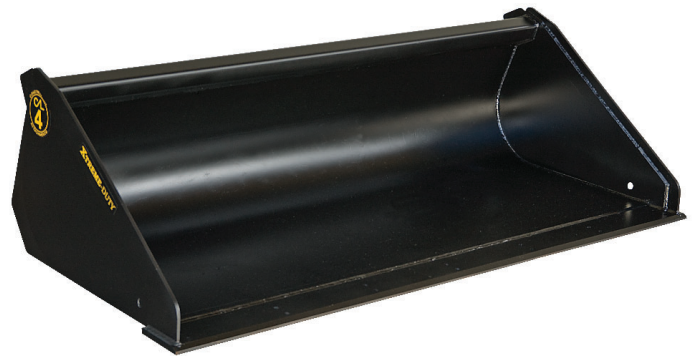

XTREME DUTY EXTENDED BOTTOM LOW PROFILE

- Available widths: 62", 66", 72", 78", 84"
- Product weight range: 506 – 992 lbs

* Product design subject to change

GENERAL PURPOSE BUCKETS



DIGGING • LEVELING • LOADING • GRADING • CARRYING • DUMPING

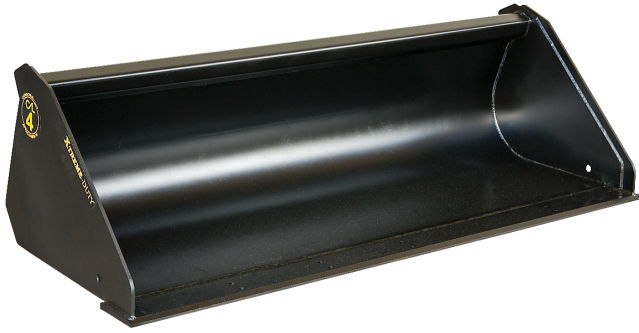

XTREME DUTY STANDARD BOTTOM LOW PROFILE

- Available widths: 62", 66", 72", 78", 84"
- Product weight range: 472 – 874 lbs



XTREME DUTY HIGH CAPACITY SCRAP

- Available widths: 66", 72", 78", 84"
- Product weight range: 510 – 1000 lbs



XTREME DUTY HIGH CAPACITY / LIGHT MATERIAL

- Available widths: 66", 72", 78", 84"
- Product weight range: 565 – 882 lbs
- Shown with optional bolt-on edge



ULTRA DUTY LOW PROFILE

- Available widths: 73", 78", 84"
- Product weight range: 726 – 1131 lbs
- Bolt-on side cutters come standard



SEVERE XTREME DUTY LOW PROFILE

- Available widths: 67", 73", 78", 84", 88"
- Product weight range: 722 – 997 lbs

GENERAL PURPOSE BUCKETS



DIGGING • LEVELING • LOADING • GRADING • CARRYING • DUMPING



XTREME DUTY AGRICULTURAL STANDARD BACK

- Available widths: 74", 84", 93"
- Product weight range: 480 – 660 lbs



SEVERE XTREME DUTY AGRICULTURAL STANDARD BACK

- Available widths: 74", 84", 93"
- Product weight range: 510 – 700 lbs



XTREME DUTY NURSERY

- Available widths: 73"
- 4" x 1/2" solide edge material
- Removeable light weight top guard



XTREME DUTY AGRICULTURAL HIGH CAPACITY LITTER

- Available widths: 74", 84", 93"
- Product weight range: 675 – 845 lbs
- Optional rub rail available; see Parts and Accessories



INDUSTRIAL TRACTOR LOADER BACKHOE

- Available widths: 84", 88", 93"
- Product weight range: 969 – 1117 lbs

* Product design subject to change

4-IN-1 MULTI-PURPOSE BUCKETS



SCRAPING • BOTTOM DUMPING • CLAMPING • DIGGING • BULL DOZING • CLAM LOADING • BACK FILLING

STANDARD FEATURES INCLUDE:

- Reversible bolt-on dozer edge
- Radius moldboard for improved material loading and unloading
- Pre-drilled high carbon steel (C1064) front cutting edge to accommodate all bolt-on options



COMPACT STANDARD BOTTOM

- Available widths: 54", 60", 66", 72"
- Product weight range: 568 - 699 lbs

MULTI-PURPOSE BUCKET

ATTACHMENT OPTIONS

Our buckets include product specific options:

- reversible bolt-on cutting edge
- bolt-on teeth
- bolt-on large teeth
- weld-on teeth
- bolt-on tooth bar
- bolt-on extended tooth bar



XTREME DUTY LOW CAPACITY

- Available widths: 60", 67", 73"
- Product weight range: 694 – 868 lbs
- Optional spill-guard available for additional capacity



XTREME DUTY LOW PROFILE

- Available widths: 67", 73", 76"
- Product weight range: 866– 1065 lbs



XTREME DUTY HIGH CAPACITY

- Available widths: 67", 73", 76"
- Product weight range: 874 – 1075 lbs

4-IN-1 MULTI-PURPOSE BUCKETS



SCRAPING • BOTTOM DUMPING • CLAMPING • DIGGING • BULL DOZING • CLAM LOADING • BACK FILLING



SEVERE XTREME DUTY LOW PROFILE

- Available widths: 67", 73", 76", 80", 84"
- Product weight range: 881 – 1152 lbs
- Shown with optional bolt-on edge and bolt-on side cutters

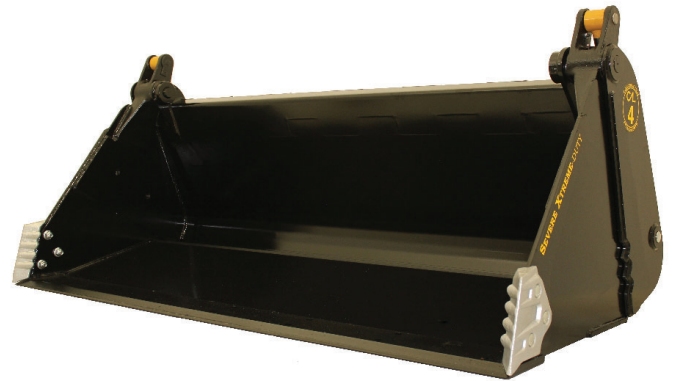

SEVERE XTREME DUTY HIGH CAPACITY

- Available widths: 80", 84"
- Product weight range: 991 – 1164 lbs
- Shown with optional bolt-on edge and bolt-on side cutters



INDUSTRIAL TRACTOR LOADER BACKHOE

- Available widths: 88", 93"
- Product weight range: 1241 – 1394 lbs
- Shown with optional bolt-on teeth



ULTRA DUTY LOW PROFILE

- Available widths: 73", 76", 80", 84"
- Product weight range: 1263– 1630 lbs
- Bolt-on side cutters come standard



SEVERE XTREME DUTY EXTENDED BOTTOM

- Available widths: 67", 73", 76", 80", 84"
- Product weight range: 1055 – 1200 lbs
- Available with bolt-on side cutters

* Product design subject to change

GRAPPLES



HANDLING LOOSE MATERIAL • SORTING DEBRIS • DEMOLITION SITE CLEAN-UP • LAND CLEARING



MINI ROOT GRAPPLE
• Available widths: 36", 48", 54"
• Product weight range: 132 – 198 lbs



COMPACT ROOT GRAPPLE
• Available widths: 54", 60", 66", 72"
• Product weight range: 454 – 518 lbs



WORX DUTY ROOT GRAPPLE
• Available widths: 66", 73", 78", 84"
• Product weight range: 768 – 863 lbs



XTREME DUTY ROOT GRAPPLE
• Available widths: 66", 73", 78", 84"
• Product weight range: 924 – 1050 lbs



SEVERE XTREME DUTY ROOT GRAPPLE
• Available widths: 66", 73", 78", 84"
• Product weight range: 950 – 1200 lbs
• Designed for high repetition duty cycles

* Product design subject to change

GRAPPLES



HANDLING LOOSE MATERIAL • SORTING DEBRIS • DEMOLITION SITE CLEAN-UP • LAND CLEARING



COMPACT GRAPPLE BUCKET

- Available widths: 54", 60", 66", 72"
- Product weight range: 547 – 631 lbs



WORX DUTY GRAPPLE BUCKET

- Available widths: 60", 67", 73", 82"
- Product weight range: 1000 – 1222 lbs
- High carbon steel (C1084) bolt-on reversible front cutting edge standard



XTREME DUTY GRAPPLE BUCKET

- Available widths: 60", 67", 73", 82"
- Product weight range: 1116 – 1372 lbs
- High carbon steel (C1084) bolt-on reversible front cutting edge standard

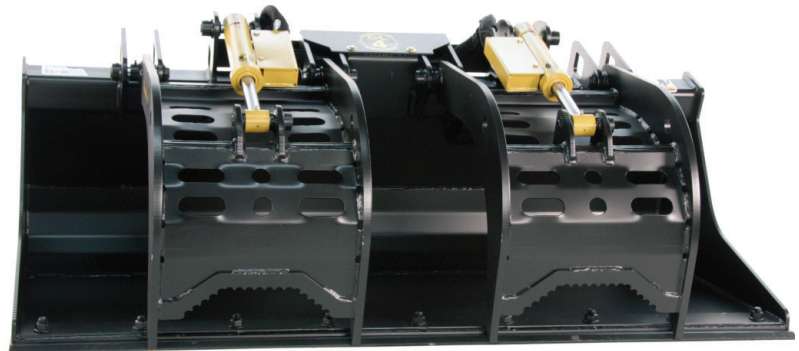

SEVERE XTREME DUTY GRAPPLE BUCKET

- Available widths: 60", 67", 73", 82"
- Product weight range: 1116 – 1372 lb
- High carbon steel (C1084) bolt-on reversible front cutting edge standard

* Product design subject to change

GRAPPLES



HANDLING LOOSE MATERIAL • SORTING DEBRIS • DEMOLITION SITE CLEAN-UP • LAND CLEARING



COMPACT ROOT RAKE WITH GRAPPLE

- Available widths: 60", 66", 72"
- Product weight range: 476 – 492lbs
- Also available without Grapple; see Specialty Attachments



XTREME ROOT RAKE WITH GRAPPLE

- Available widths: 74", 80", 86"
- Product weight range: 1150 – 1400lbs
- Also available without Grapple; see Specialty Attachments



MINI SKELETON GRAPPLE

- Available widths: 36", 48", 56"
- Product weight range: 335 – 400 lbs
- Also available without Grapple; see Specialty Attachments



XTREME DUTY SKELETON GRAPPLE

- Available widths: 66", 73", 82"
- Product weight range: 1108 – 1266 lbs
- Also available without Grapple; see Specialty Attachments



SEVERE XTREME DUTY STUMP GRAPPLE BUCKET

- 55" plus grapple opening
- Product weight range: 978 lbs
- Also available without Grapple; see Specialty Attachments

PALLET FORKS



LIFTING • CARRYING



COMPACT

- Fork lift capacity: 2,200 lbs
- Available fork length: 42"



WORX DUTY

- Fork lift capacity: 4,200 lbs
- Available fork length: 42", 48"
- Skid steer universal hitch only
- Optional custom name cutout



XTREME DUTY STANDARD FRAME

For Skid Steer Universal Hitch

- Fork lift capacity: 4,200, 5,500, *6,400 lbs
- Available fork length: 42", 48", 60", 72", *96"
- Frame width: 45-1/2"

* Product design subject to change

PALLET FORKS



LIFTING • CARRYING



XTREME DUTY WIDE FRAME

For Skid Steer Universal Hitch

- Fork lift capacity: 4,200, 5,500, *6,400 lbs
- Available fork length: 42", 48", 60", 72", *96"
- Frame width: 57"



XTREME DUTY STANDARD FRAME

For AG Style Hitch

- Fork lift capacity: 4,200, 5,500, *6,400 lbs
- Available fork length: 42", 48", 60", 72", *96"
- Frame width: 45-1/2"



XTREME DUTY WIDE FRAME

For AG Style Hitch

- Fork lift capacity: 4,200, 5,500, *6,400 lbs
- Available fork length: 42", 48", 60", 72", *96"
- Frame width: 57"

PALLET FORKS



LIFTING • CARRYING



XTREME DUTY WALK-THROUGH

- Fork lift capacity: 4,200, 5,500, *6,400 lbs
- Available fork length: 42", 48", 60", 72", *96"
- 14" opening for easy machine access



XTREME DUTY SHAFT MOUNT

- Fork lift capacity: 4,200 -5,500 lbs
- Available fork length: 48"
- 1-3/4" diameter shaft
- Ball fork sleeves available
(see Specialty Attachments section)



XTREME DUTY HYDRAULIC

- Fork lift capacity: 5,500 lbs
- Available fork length: 48"
- Dual fork carrier shaft's
- Ball fork sleeves available
(see Specialty Attachments section)

* Product design subject to change

PALLET FORKS



LIFTING • CARRYING



XTREME DUTY THREE POINT HITCH

- Fork lift capacity: 4,200 lbs
- Available fork length: 48"
- Fixed 22" spaced forks equipped with category 1 lower pins



INDUSTRIAL DUTY

- Fork Capacity: 5,500 - 6,400 lbs
- Available fork length: 42", 48"



XTREME DUTY SWING OVER FORK ASSEMBLY

Pallet forks shown installed on bucket; bucket not included

- Fork lift capacity: 5,500 lbs
- Available fork length: 42"
- Forks mount on bucket for quick use then fold over and latch for storage

SPECIALTY ATTACHMENTS



NURSERIES • FARMS • FORESTRY • LANDSCAPING • CONSTRUCTION • SNOW AND ICE



XTREME DUTY SINGLE BALE SPEAR

- Rated spear capacity: 3,500 lbs @ 23" from collar
- 43.5" usable spear length



XTREME DUTY WIDE FRAME SINGLE BALE SPEAR

- Rated spear capacity: 3,500 lbs @ 23" from collar
- 43.5" usable spear length



XTREME DUTY DUAL BALE SPEAR

- Rated spear capacity: 3,500 lbs @ 23" from collar
- Usable spear length 43.5"
- 30" spacing between spears

* Product design subject to change

SPECIALTY ATTACHMENTS



NURSERIES • FARMS • FORESTRY • LANDSCAPING • CONSTRUCTION • SNOW AND ICE



XTREME DUTY WIDE FRAME DUAL BALE SPEAR

- Rated spear capacity: 3,500 lbs @ 23" from collar
- 43.5" usable spear length
- 30" spacing between spears



XTREME DUTY WIDE FRAME TRIPLE BALE SPEAR

- Rated spear capacity: 3,500 lbs @ 23" from collar
- Usable spear length 43.5"
- 23.25" spacing between spears



XTREME DUTY WIDE FRAME QUADRUPLE BALE SPEAR

- Rated spear capacity: 3,500 lbs @ 23" from collar
- Usable spear length 43.5"
- 30" spacing between spears

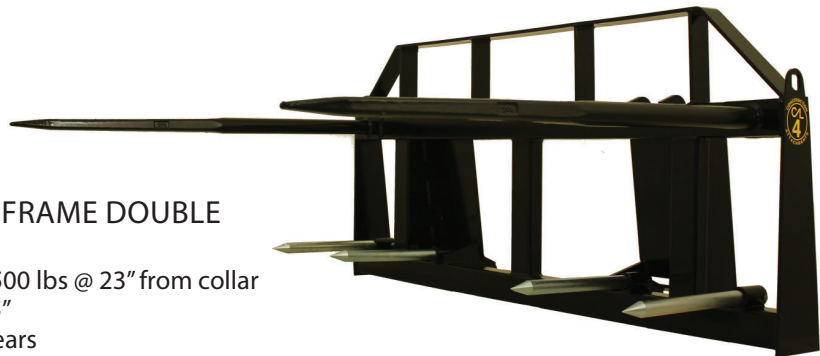

XTREME DUTY WIDE FRAME DOUBLE SINGLE BALE SPEAR

- Rated spear capacity: 3,500 lbs @ 23" from collar
- Usable spear length 43.5"
- 60" spacing between spears

SPECIALTY ATTACHMENTS



NURSERIES • FARMS • FORESTRY • LANDSCAPING • CONSTRUCTION • SNOW AND ICE



XTREME DUTY BOOM POLE
Available with open hook or closed lug design
• Also available in wide frame
• Rated lifting capacity: 1,500 lbs



XTREME DUTY TREE BOOM
• Adds 62" to lifting height of the machine
• Rated lifting capacity: 1,800 lbs



XTREME DUTY REAR STABILIZER
• Provides additional stability to the rear of skid steer loaders



XTREME DUTY TRAILER RELOCATOR
• Maximum gross towing weight of 10,000 lbs
• 2" square receiver tube
• Product weight: 160 lbs

XTREME DUTY BALL FORK SLEEVES
Shown on pallet frame; pallet frame not included
• Designed to work with standard class II forks
• Used for transporting nursery stock



* Product design subject to change

SPECIALTY ATTACHMENTS



NURSERIES • FARMS • FORESTRY • LANDSCAPING • CONSTRUCTION • SNOW AND ICE



- WORX DUTY STUMP BUCKET**
- Standard 3/4" x 6" cutting Edge with three weld-on teeth
 - 408 lbs



- XTREME DUTY STUMP BUCKET**
- Standard 3/4" x 6" cutting edge with three weld-on teeth
 - 581 lbs



- MINI SKELETON BUCKET**
- Available widths: 36", 48", 56"
 - Product weight range: 170 - 235 lbs



- XTREME DUTY SKELETON BUCKET**
- Available widths: 66", 73", 82"
 - 2-7/16" tine spacing for screening
 - Product weight range: 530 - 675 lbs



- COMPACT ROOT RAKE**
- Available widths: 60", 66", 72"
 - Product weight range 500 - 600 lbs



- XTREME DUTY ROOT RAKE**
- Available widths: 74", 80", 86"

SPECIALTY ATTACHMENTS



NURSERIES • FARMS • FORESTRY • LANDSCAPING • CONSTRUCTION • SNOW AND ICE

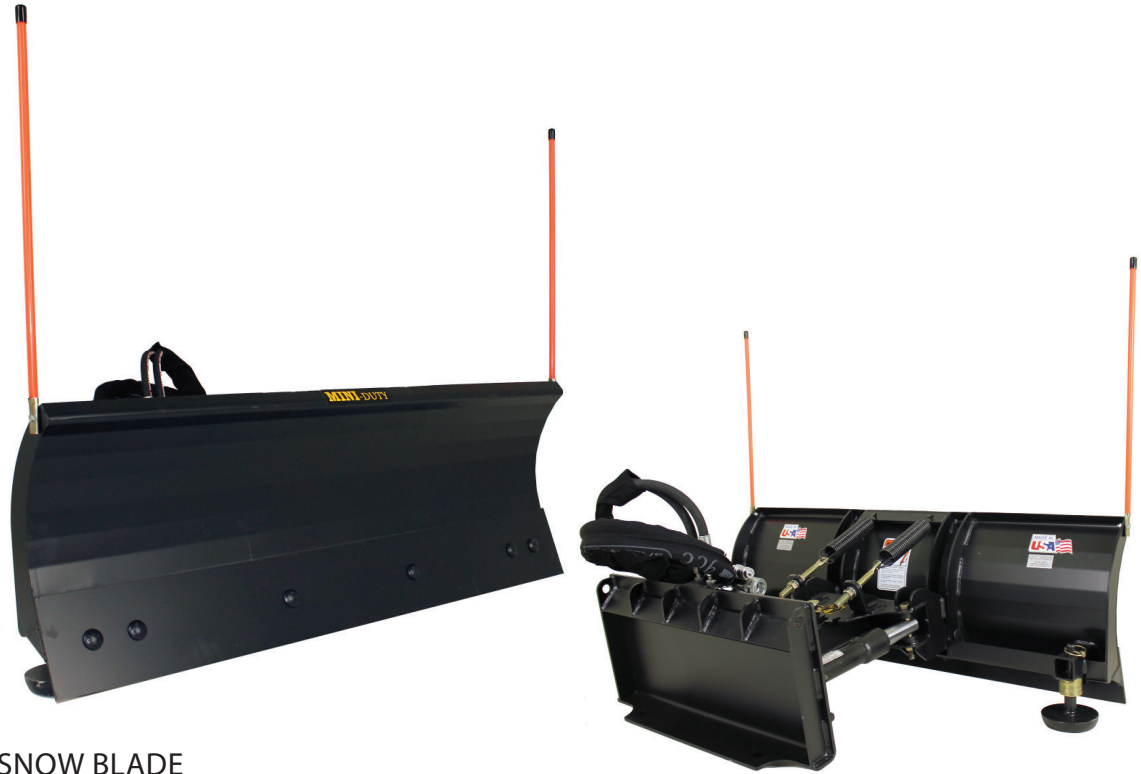

MINI SNOW BLADE

- Available widths: 36", 48", 54"
- Product weight range: 200 - 275 lbs
- Available in manual or hydraulic angle operation

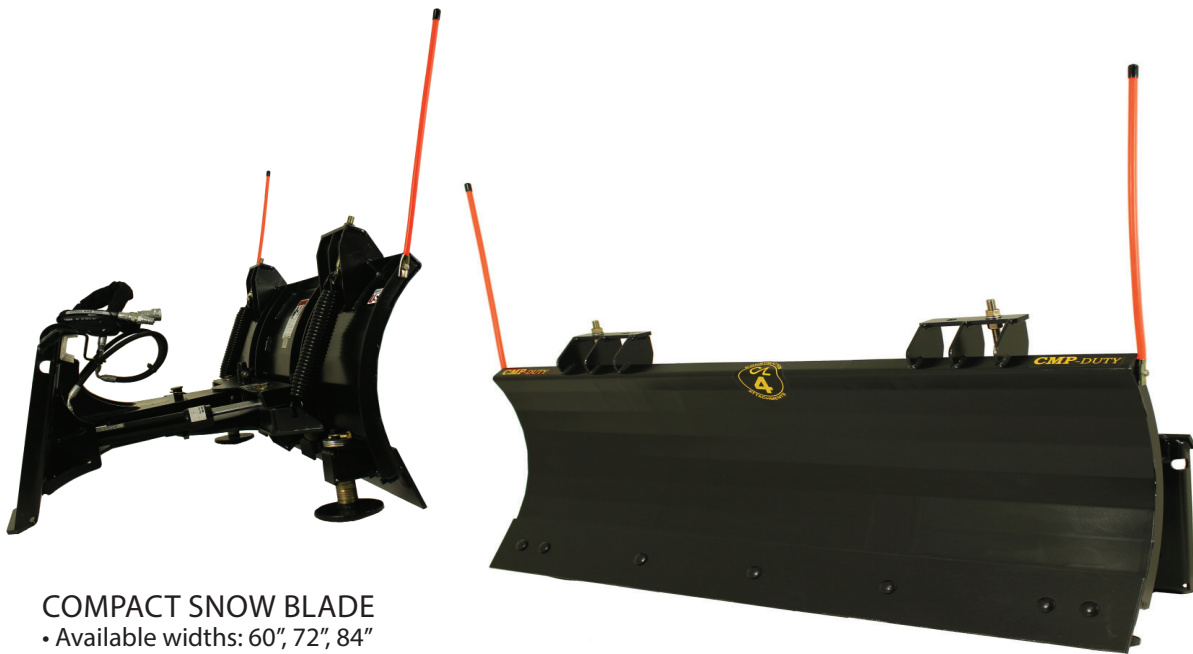

COMPACT SNOW BLADE

- Available widths: 60", 72", 84"
- Product weight range: 400 - 460 lbs
- Available in manual or hydraulic angle operation

* Product design subject to change

SPECIALTY ATTACHMENTS



NURSERIES • FARMS • FORESTRY • LANDSCAPING • CONSTRUCTION • SNOW AND ICE

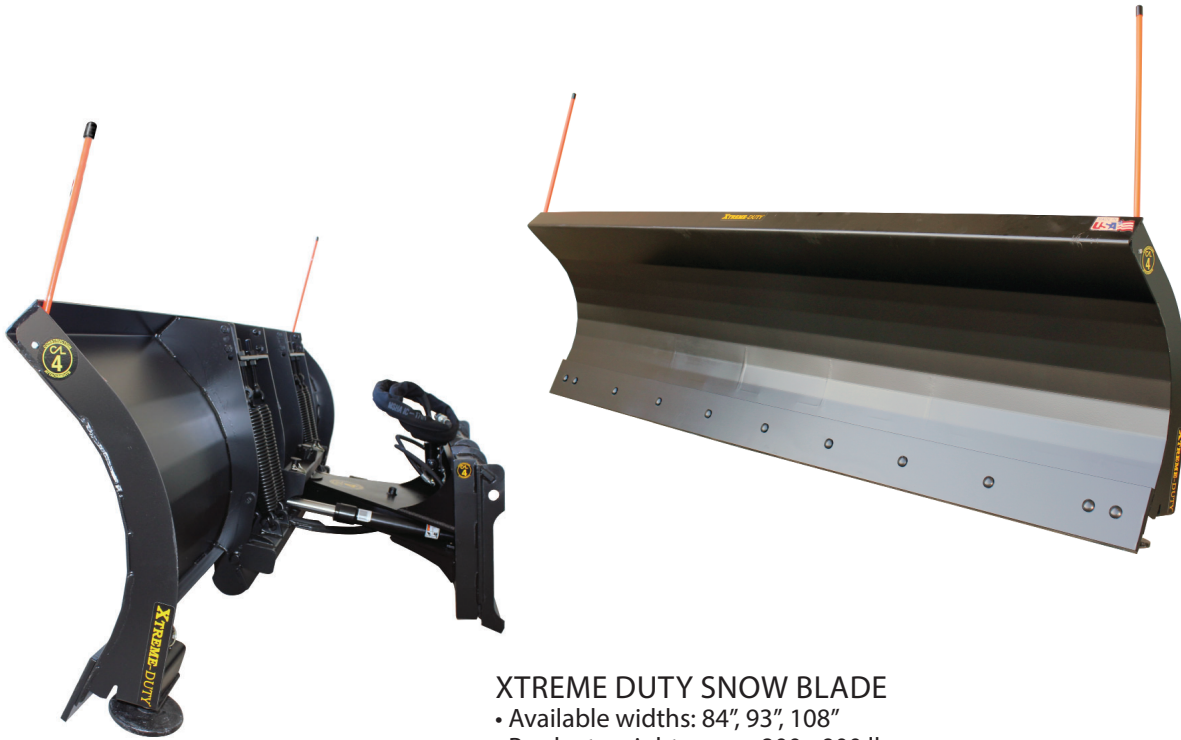

XTREME DUTY SNOW BLADE

- Available widths: 84", 93", 108"
- Product weight range: 800 - 900 lbs
- Available in manual or hydraulic angle operation

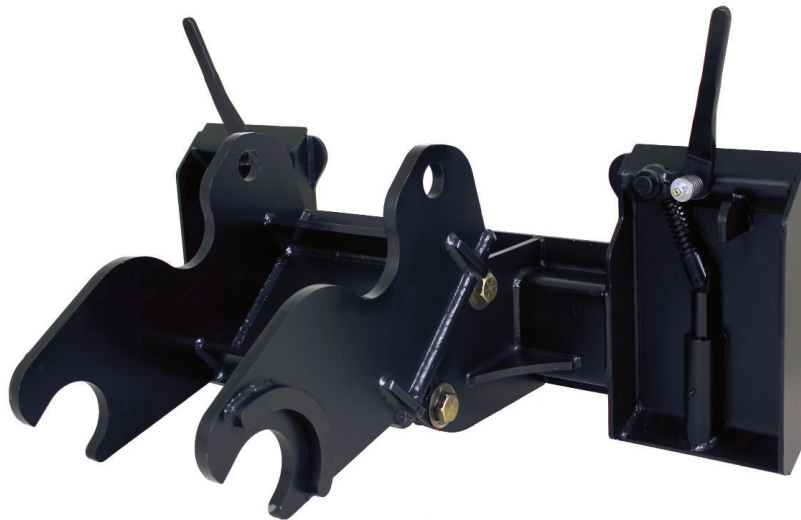

SKID STEER ADAPTER "THE HOOKUP"

- Skid steer universal adapter for excavators
- For excavators up to 20,000 lbs
- Product weight: 252 lbs

TOOTH BARS



COMPACT DUTY BOLT-ON TOOTH BAR

- Available widths: 48" - 75"
- Designed to accommodate compact tractor buckets up to 1/2" thick front edge
- Equipped with case 2A tooth



XTREME DUTY BOLT-ON TOOTH BAR

- Available widths: 48" - 85"
- Designed to accommodate 3/4" weld-on edges
- Equipped with 23 series tooth



XTREME DUTY BOLT-ON EXTENDED TOOTH BAR

- Available widths: 48" - 85"
- Designed to accommodate both weld-on and bolt-on edges, combined thickness of 1-1/2"
- Equipped with 23 series tooth

BOLT-ON EDGES



BOLT-ON REVERSIBLE CUTTING EDGES

- Designed to work with Construction Attachments general purpose, multi-purpose, and grapple buckets
- Adds protection and longevity to your original front edge



BOLT-ON REVERSIBLE SNOW BLADE EDGES

- Designed to work with Construction Attachments snow blades
- Available in rubber or steel

BOLT-ON TEETH



REGULAR BOLT-ON TEETH

- Designed to work with Construction Attachments general purpose, and multi-purpose buckets
- Necessary when loosening compacted soil, digging, or excavating

LARGE BOLT-ON TEETH

- Designed to work with Construction Attachments general purpose, and multi-purpose buckets
- Necessary when loosening compacted soil, digging, or excavating

HITCH PLATES

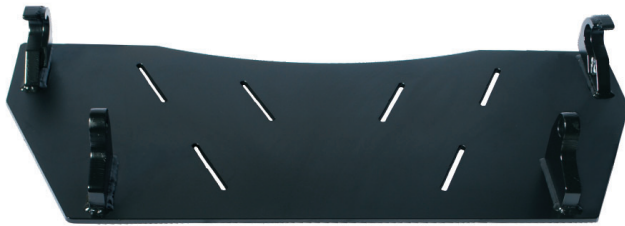

EURO STYLE - DELUXE SOLID HITCH PLATE ASSEMBLY

- Single plate design, pre-located hooks
- 3/8" plate backing material



UNIVERSAL STYLE - BLANK HITCH PLATE ASSEMBLY

- Constructed of two independent hitch plates for reduced weight
- 3/8" plate material with a full length top rail



UNIVERSAL STYLE - DELUXE SOLID HITCH PLATE ASSEMBLY

- Designed for heavier applications
- 3/8" plate backing material

ONE TOUCH KITS

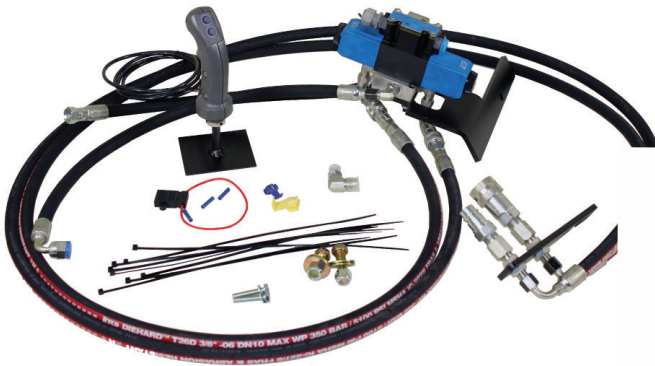

D03 DIRECT FIT ONE TOUCH HYDRAULIC KIT

- For tractors with 14 gpm of auxiliary flow
- Kit pictured for a Kubota LA-524
- Sold with standard 2 button handle
- Optional: 2 button rocker switch handle
4 button handle
- Specify make and model of host machine



D05 DIRECT FIT ONE TOUCH HYDRAULIC KIT

- For tractors with 14.1 - 25 gpm of auxiliary flow
- Kit pictured for a Kubota 1353 Cab
- Sold with standard 2 button handle
- Optional: 2 button rocker switch handle
4 button handle
- Specify make and model of host machine



UNIVERSAL DIVERTER TYPE ONE TOUCH HYDRAULIC KIT

- For tractors with 20gpm of auxiliary flow
- Specify make and model of host machine
- Sold with standard 2 button handle
- Optional: 2 button rocker switch handle
4 button handle

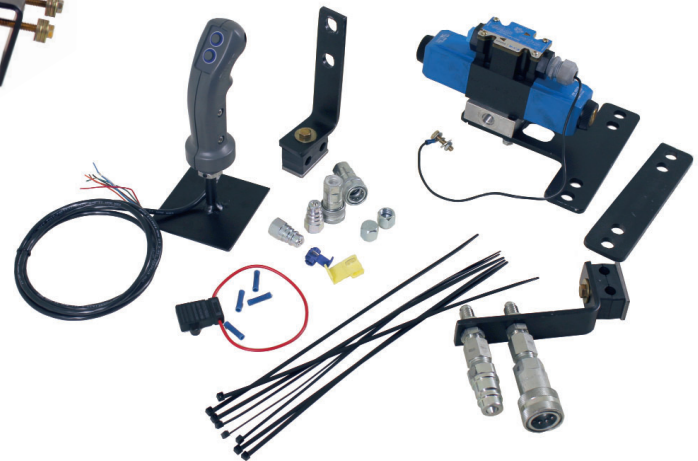

D03 DIRECT FIT ONE TOUCH PARTIAL HYDRAULIC KIT

- For tractors with 14 gpm of auxiliary flow
- Partial kit does not include hoses
- Sold with standard 2 button handle
- Optional: 2 button rocker switch handle
4 button handle
- Specify make and model of host machine



2 BUTTON ROCKER SWITCH HANDLE FOR DIRECT FIT ONE TOUCH HYDRAULIC KITS

- Optional
- Additional charge applies
- Specify make and model of host machine



4 BUTTON HANDLE FOR DIRECT FIT ONE TOUCH HYDRAULIC KITS

- Optional
- Additional charge applies
- Specify make and model of host machine

OTHER

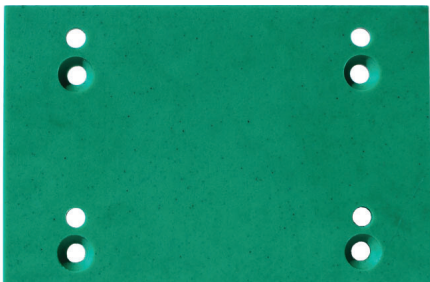

RUB RAILS

- Designed for use on Construction Attachments
High Capacity Litter Buckets
- Made of 1/2" x 8" UHMW polyethylene plastic material



SNOW BLADE HYDRAULIC KIT

- Designed for use on Construction Attachments
Mini, Compact and Xtreme Duty snow blades

CONSTRUCTION ATTACHMENTS, INC.®



A TRADITION OF QUALITY

Construction Attachments is a leading manufacturer of construction and agricultural grade attachments for tractors, compact excavators, skid steer loaders, tractor loader backhoes, and large excavators.

**"THE BITTERNESS OF POOR QUALITY LINGERS LONG AFTER
THE SWEETNESS OF A CHEAP PRICE IS FORGOTTEN!"**



